

# NeoScope

**JCM-5000**  
Table Top SEM

Simple  
Operation to  
×40,000



**JEOL**

Serving Advanced Technology

# From $\times 10$ to $\times 40,000$

## Table Top SEM

### NeoScope



Notebook PC version



Just plug it to a wall outlet after placing it on a table

Desktop PC version



Option



# Just a few suggestions Application as wide as your imagination

## Observation at higher magnification



Magnification  $\times 0.5 \sim \times 1,500$



Magnification  $\times 10 \sim \times 40,000$

- Larger depth of focus
- High magnification
- High resolution

## Check a specimen before sending it out to analytical lab



## Sampling inspection done with the ease of light microscope

Products



Good products

Rejected products

- 1 Operation is easy. You can learn it in a short time.
- 2 High quality image by secondary electrons
- 3 Up to 70mm diameter  $\times$  50mm height specimen
- 4 Measurement in nanometer
- 5 My recipe for reliable results
- 6 Smile View for quick report editing
- 7 Maintenance is easy



# Sharp image at high magnification

## Larger depth of focus

A scanning electron microscope (SEM) has about 10 times larger depth of focus so that you can focus even on an extremely rough specimen. You can understand complicated structures easily.

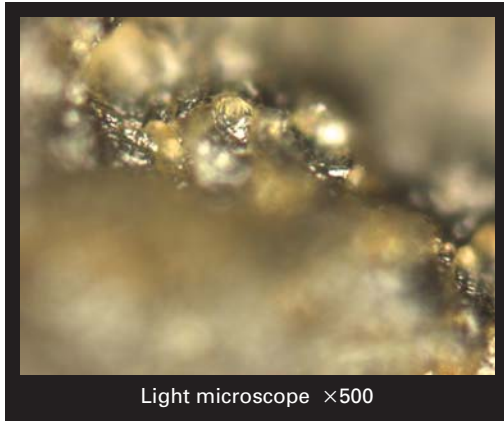

Light microscope  $\times 500$

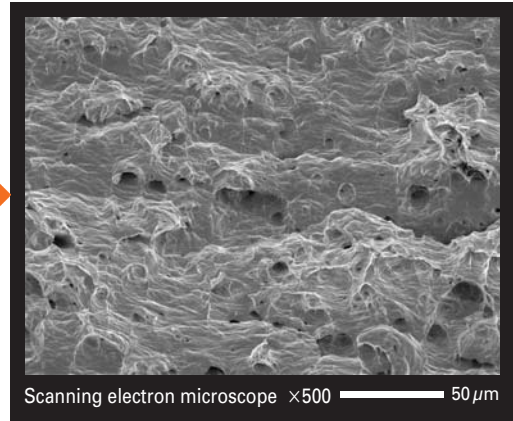

Scanning electron microscope  $\times 500$   $50 \mu\text{m}$

Specimen : Fracture surface of brass screw

## Continuous zoom up from the lowest magnification High magnification image in no time



Mouse changes magnification continuously. No focus change when magnification is changed.

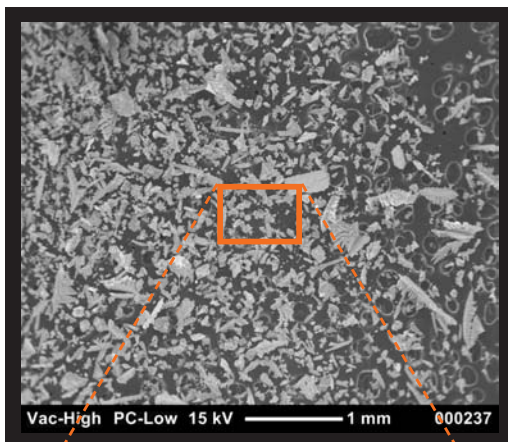

$\times 24$

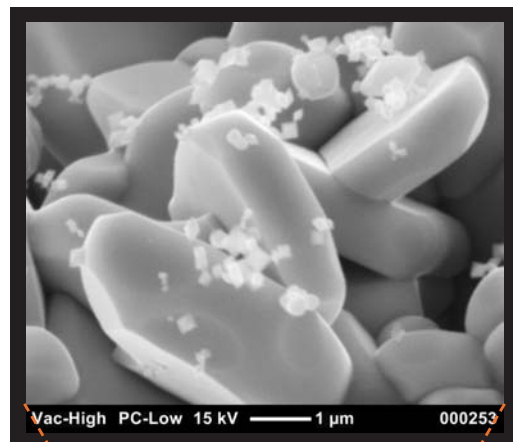

$\times 15,000$

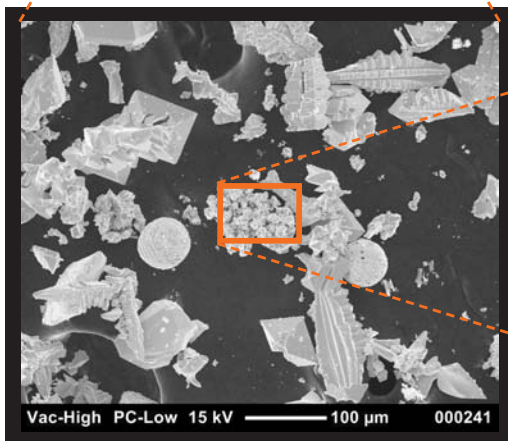

$\times 200$

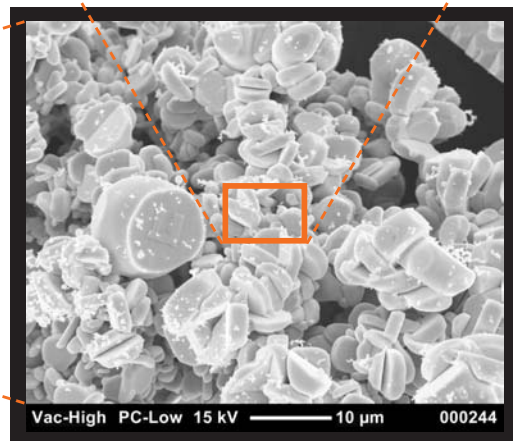

$\times 2,000$

Specimen : Zinc oxide





# Realistic high magnification $\times 20,000$ by secondary electron (SE) image in high vacuum

JCM-5000 NeoScope goes up to  $\times 20,000$  and shows realistic surface image by secondary electron image at the high vacuum mode. The depth of focus is large enough to easily understand complicated morphology. The high vacuum mode keeps high performance for a long period of time.

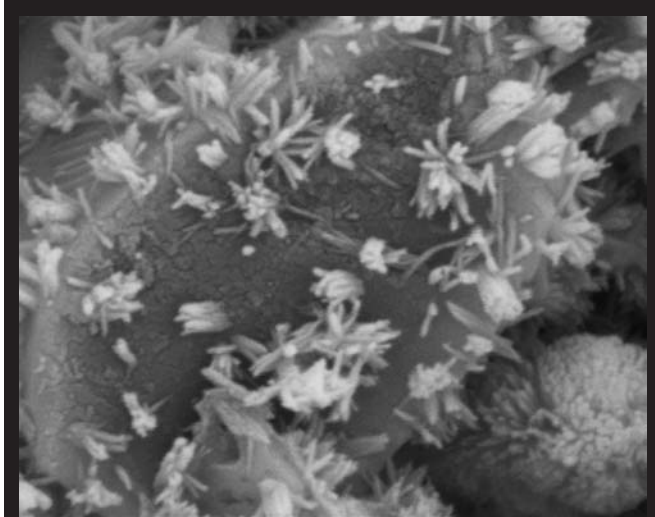

Vac-High PC-Low 10 kV  $\times 20000$  1  $\mu\text{m}$  000121

Cement, Secondary electron image, original mag:  $\times 20,000$  (with coating)  
This is cement mix for DIY mixed with water and set for 30 minutes. Cement crystals are growing on sand grains. Gold conductive coating has been applied by a sputter coater.



Vac-High PC-Low 15 kV  $\times 20000$  1  $\mu\text{m}$  000314

Zinc oxide, Secondary electron image, original mag:  $\times 20,000$  (no coating)  
The specimen is conductive enough to be observed without conductive coating. You can observe particles smaller than 0.1micron (100nm).

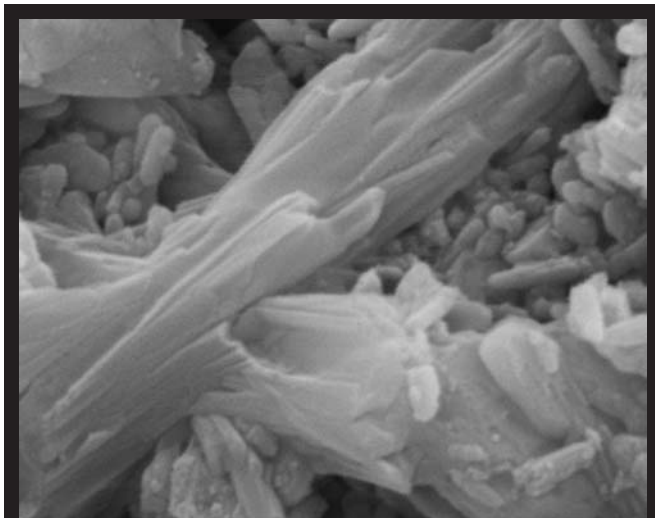

Vac-High PC-Low 15 kV  $\times 20000$  1  $\mu\text{m}$  000108

Gypsum, Secondary electron image, original mag:  $\times 20,000$  (with coating)  
Gypsum was mixed with water and set for a few minutes. Fine long crystals are observed. Gold conductive coating has been applied by a sputter coater.

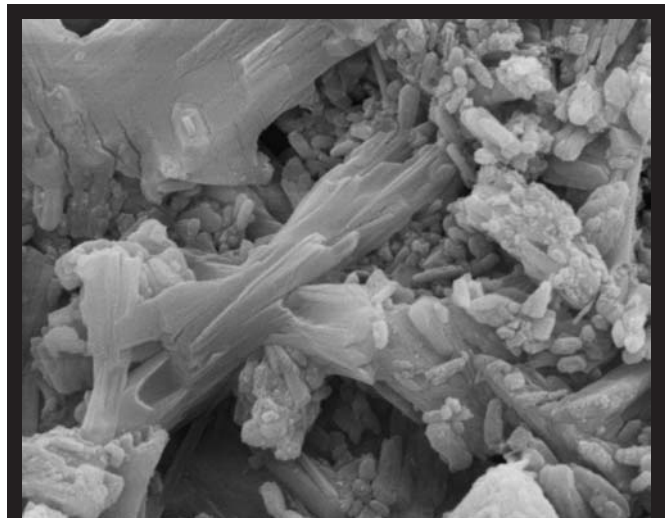

Vac-High PC-Low 15 kV  $\times 10000$  2  $\mu\text{m}$  000109

Gypsum, Secondary electron image, original mag:  $\times 10,000$  (with coating)  
A wider view was observed at a slightly lower magnification. Small particles are observed with long crystals.



# Large specimen can be observed

A small specimen is observed by putting it on a specimen mount.

A large specimen up to 70mm diameter and 50mm height can be set on the 70mm specimen holder.

You can use carbon double sticky tape to fix a specimen on a mounting block or a holder.

Then set the specimen holder on the specimen stage. Closing the specimen stage starts pumping automatically.

The specimen stage moves 35mm on both X and Y axes. The specimen stage is stable enough to show a clear image at  $\times 20,000$ .

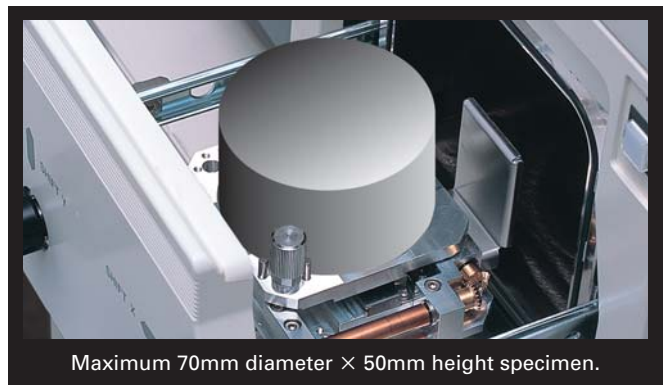

Maximum 70mm diameter  $\times$  50mm height specimen.



Pull out the specimen stage and set a specimen holder on it.



Close the specimen stage starts pumping automatically.



# Specimen holder and specimen mount

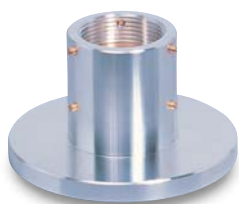

25mm diameter specimen holder\*

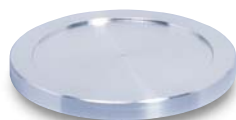

70mm diameter specimen holder\*



35mm diameter specimen holder



25mmDia  $\times$  25mmH\*

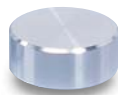

25mmDia  $\times$  10mmH\*



Calibration specimen\*

Specimen holder	
Standard specimen holder	25mm diameter specimen holder
	70mm diameter specimen holder
	35mm diameter specimen holder
Optional specimen holder	Tilting specimen holder
Specimen mount	25mmDia $\times$ 10mmH
	25mmDia $\times$ 25mmH
	35mmDia $\times$ 10mmH
	Pre-tilt specimen mount (custom made)

\*Standard



# Observation Let's observe in the high vacuum mode

A secondary electron image appears automatically on the monitor when the specimen chamber is pumped to high vacuum. The operation condition is the Standard Recipe, which give good results for most of specimens at 10kV. This condition reveals fine surface structures of a specimen clearly.

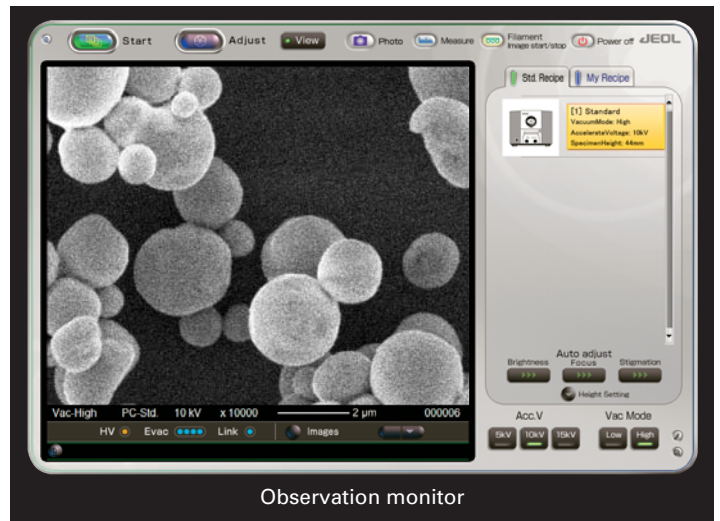

Observation monitor



# Observation made easy by the recipe

The optimum operation conditions may vary depending on the material or shape of a specimen, or magnification for observation. Some specimens may produce better results by using an accelerating voltage or probe current different from the Standard Recipe. When you find a better operation conditions for your specimen, you can store them in My Recipe and reuse it when you observe a similar specimen later.

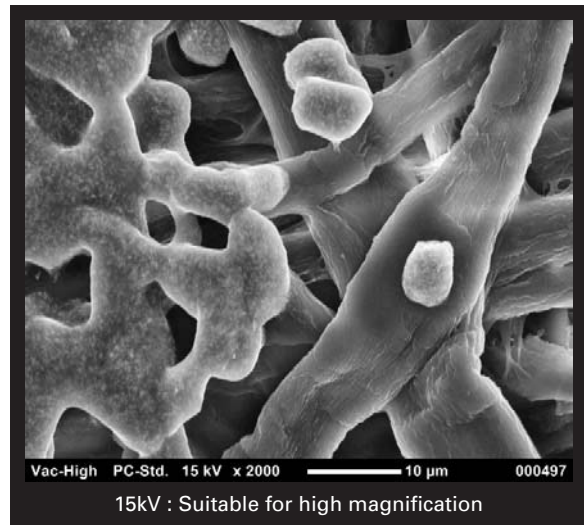

15kV : Suitable for high magnification

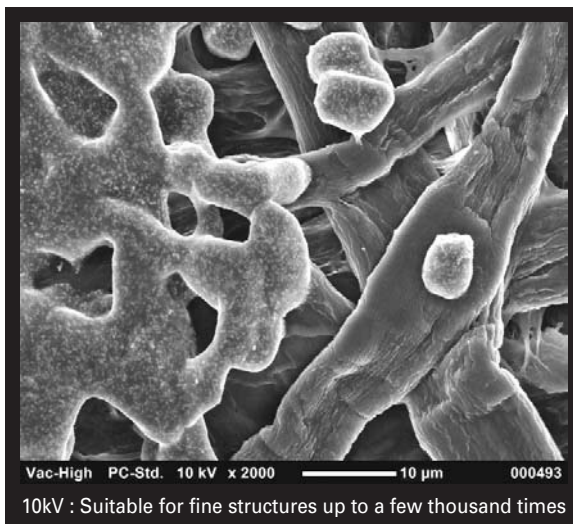

10kV : Suitable for fine structures up to a few thousand times

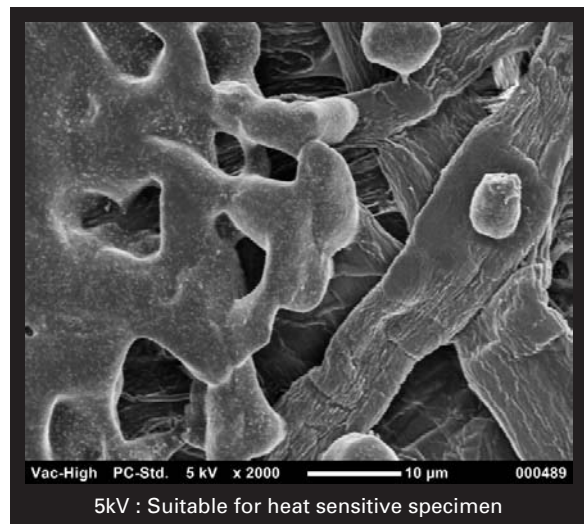

5kV : Suitable for heat sensitive specimen

Specimens : Business card





# Adjustment of image

The contrast and brightness of image can be controlled automatically or manually.

## Automatic operation

First click on the Auto Contrast & Brightness for automated adjustment. You can adjust contrast and brightness manually as well. Then click on the Auto Focus to focus the image. At high magnifications you may need to compensate astigmatism.

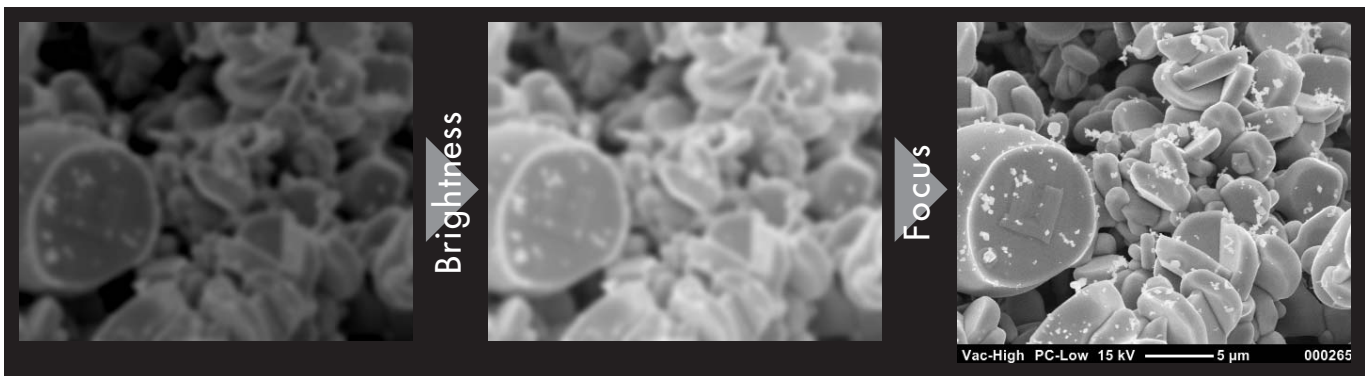
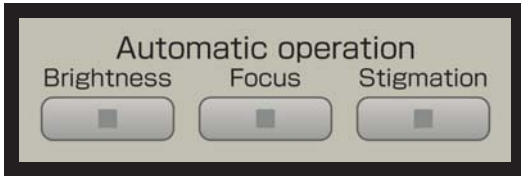

## Manual operation

- **Image adjustment**  
You can adjust contrast and brightness manually as well.
- **Focus**  
Focus can be manually adjusted as well as automatically.
- **Astigmatism correction**  
Fine astigmatism adjustment is available in addition to the automatic correction.
- **Image shift**  
You can shift the image by a mouse drag. This is convenient at high magnification.
- **Image Rotation**  
You can rotate a live image on the monitor by 1 degree step or 90 degree step.







# Measurement mode

You can measure a distance between two points just by a click on each point.  
The result is pasted on the image.

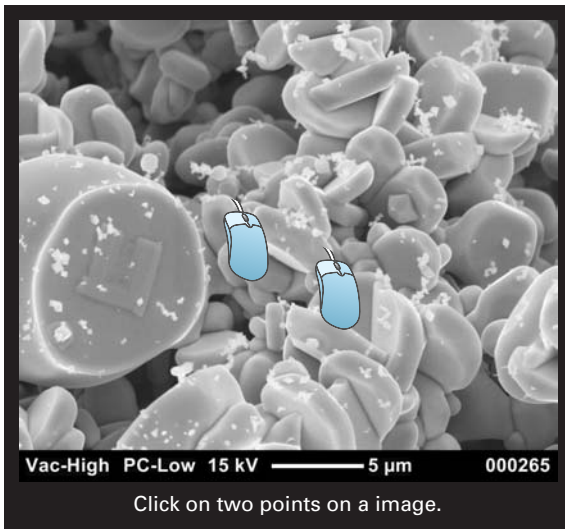

Click on two points on a image.

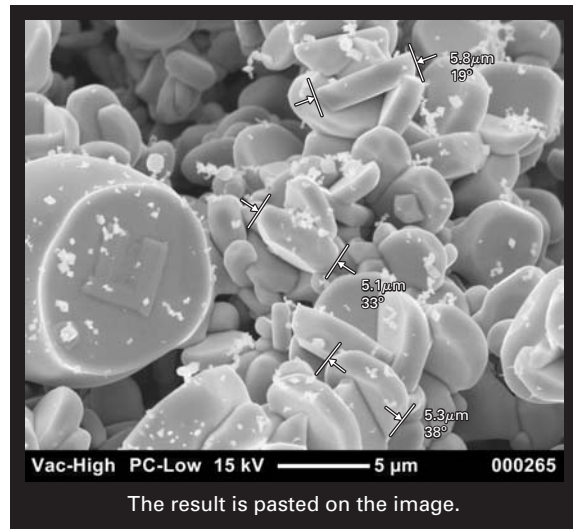

The result is pasted on the image.



# Report Creation (Option)

Images obtained by the SEM are pasted on a layout sheet of Smile View (Option) to create a report.  
The acquired images are displayed in small thumb nail images. Simply drag and drop these image onto a layout sheet.  
You can freely edit your own layout by changing the size of each image and position.  
Magnification is automatically calibrated and displayed as you change the size of image.  
SMile View also has a measurement mode. You can measure on a layout sheet and result is pasted on the report.

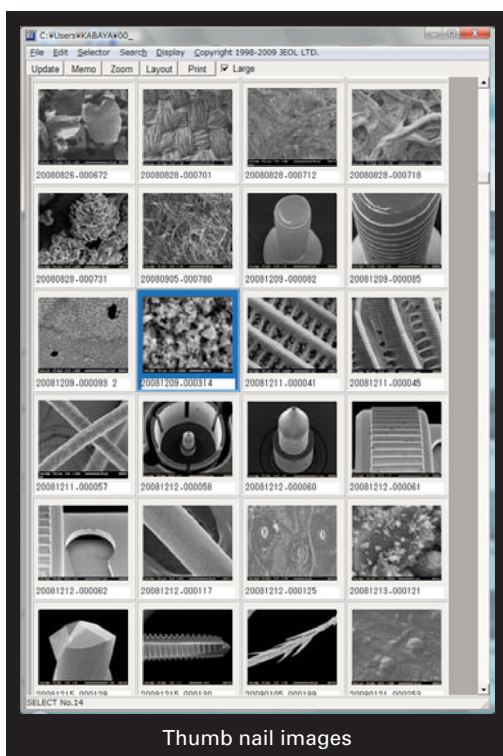

Thumb nail images

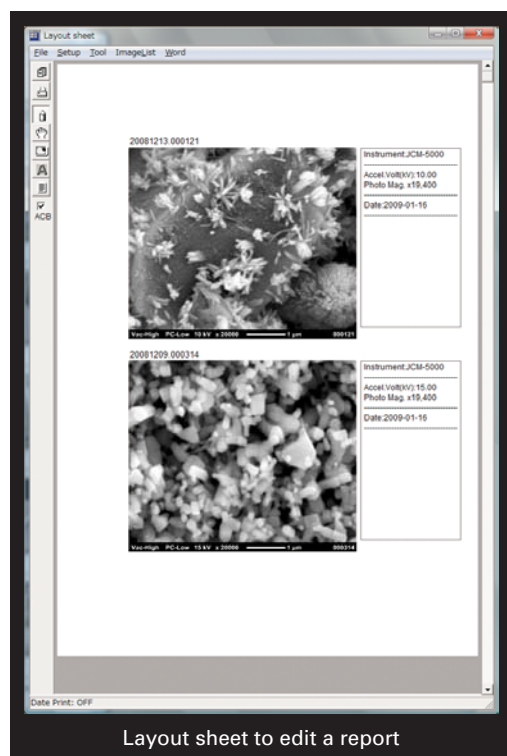

Layout sheet to edit a report



# Large Depth of Focus

Complicated morphology observed by SE image in high vacuum

A scanning electron microscope (SEM) is unique due to its large depth of focus together with high resolution. You can observe clearly a rough specimen difficult for a light microscope to focus. The lowest magnification is  $\times 10$ . You can find an area located by a light microscope easily.

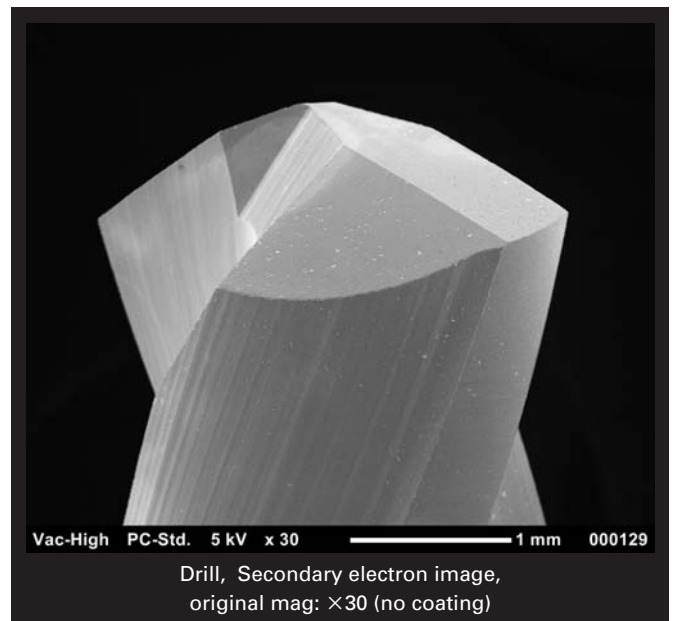
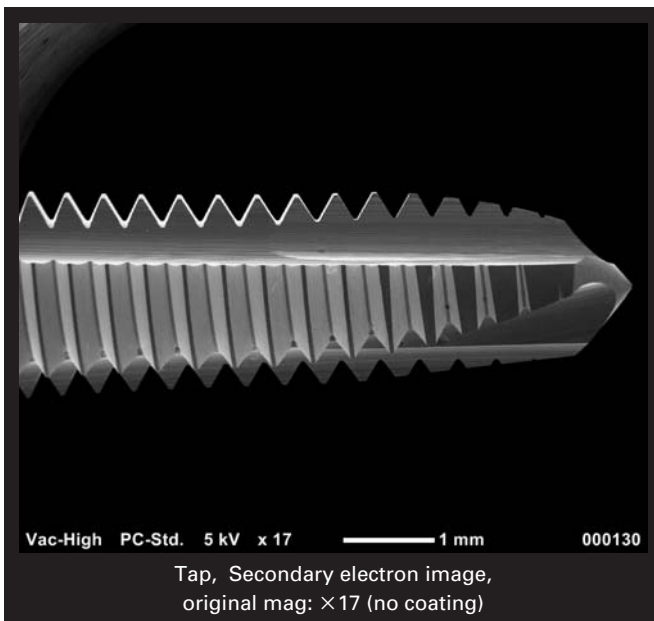
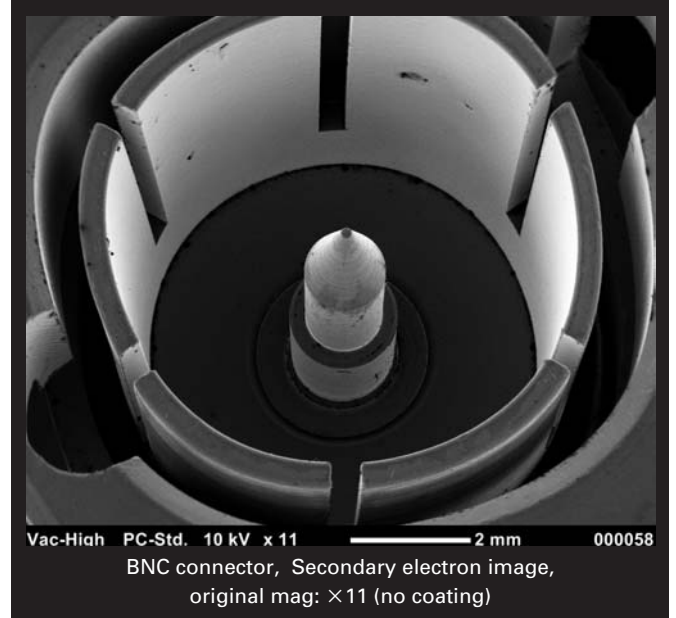
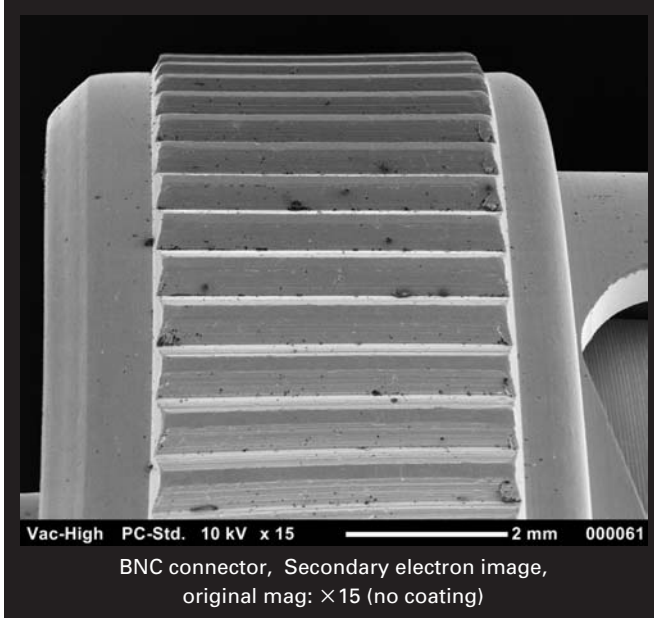



# Industrial Products

Quality control by high quality SE and BSE images

An SEM lets you observe complicated structures clearly in details with high resolution. This unique feature of an SEM is widely used in the industry from research to quality control.

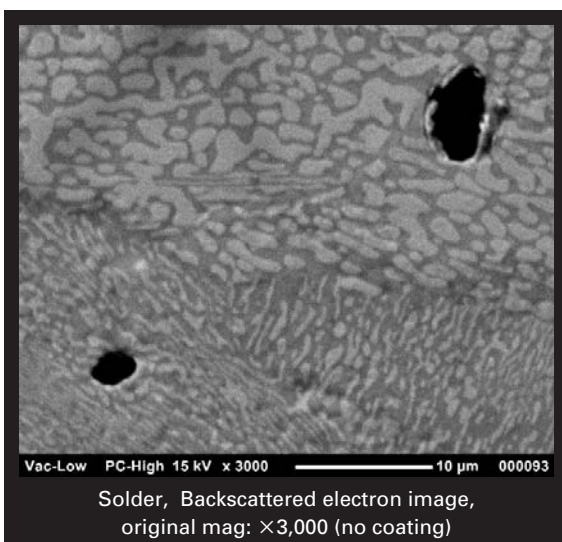
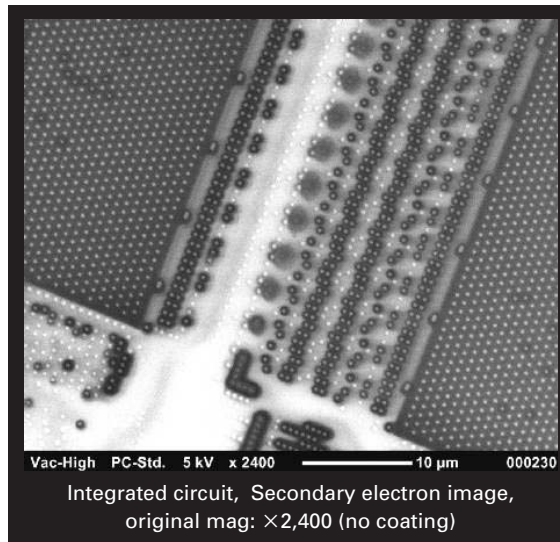
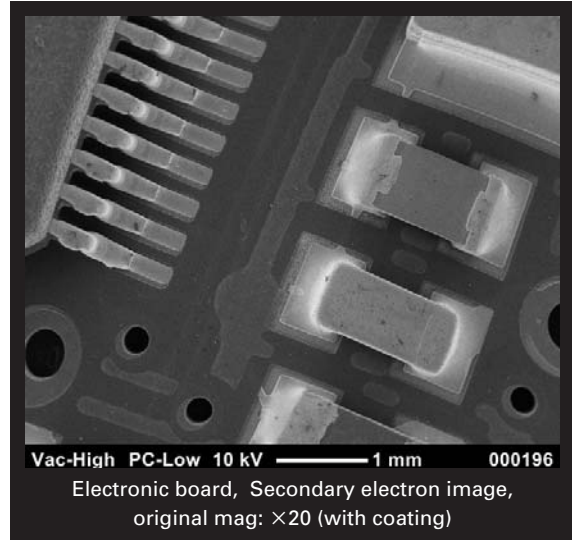
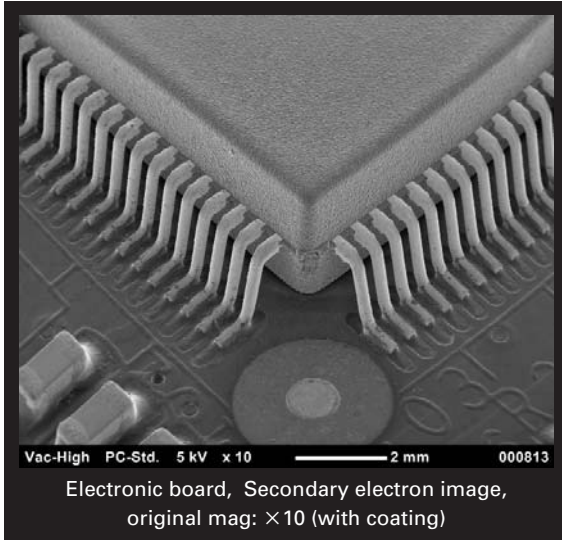





An SEM is widely used in the industry from research to quality control.

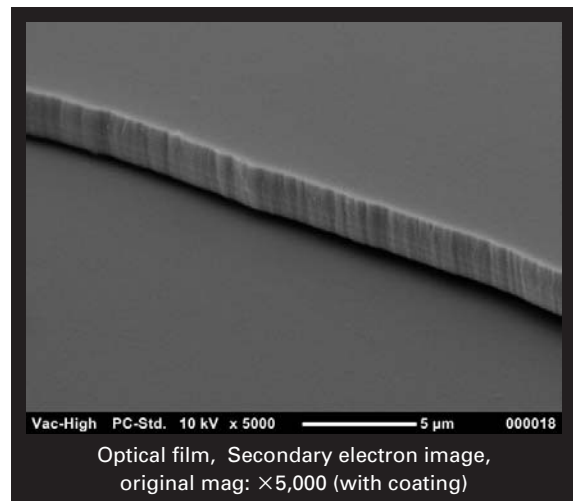
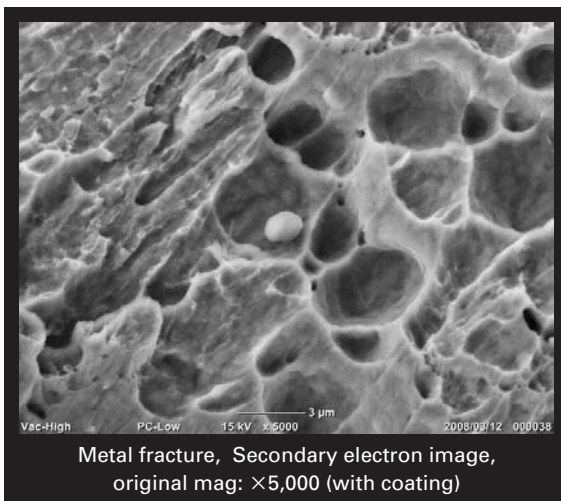
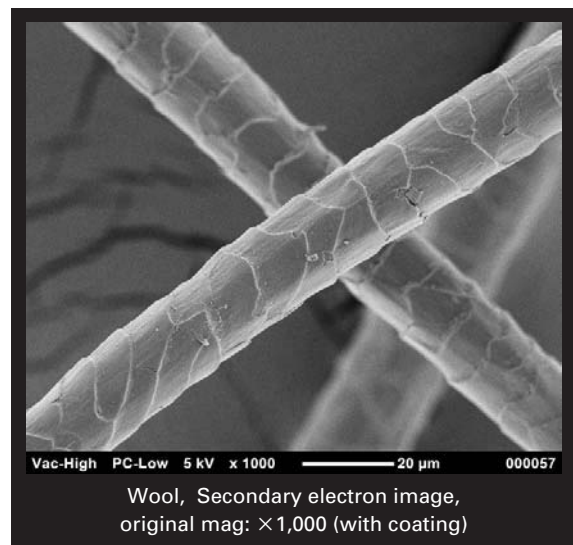
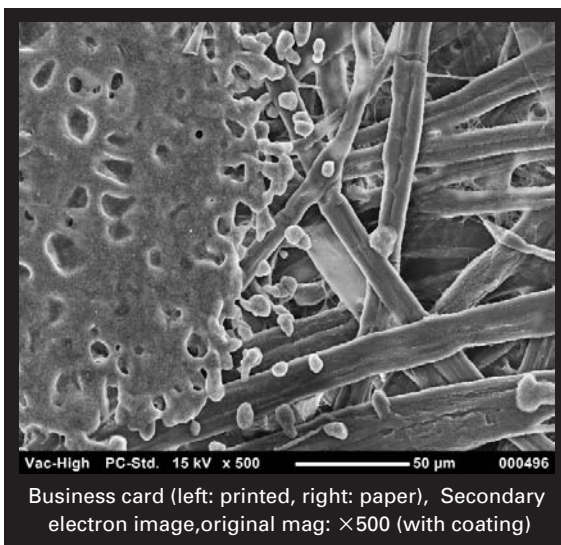
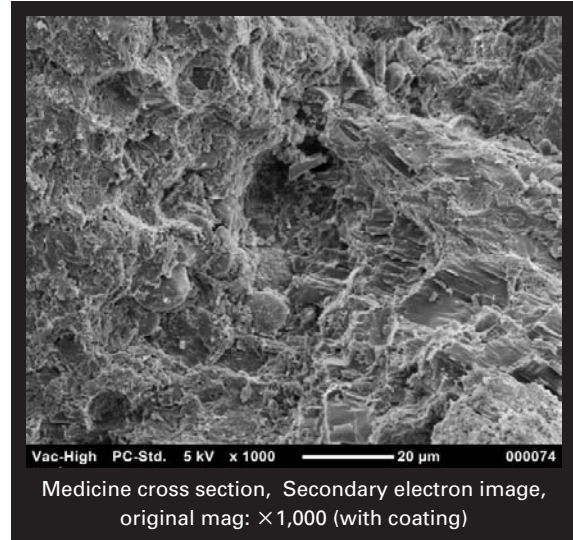
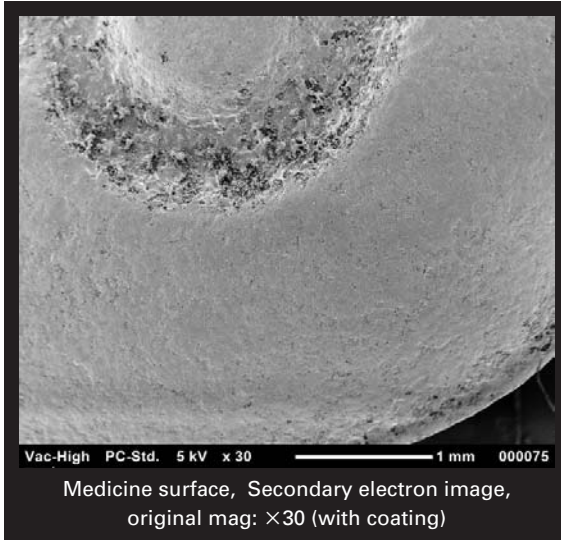





# Plant Product High quality SE image with conductive coating

Plant products such as lumber do not have electric conductivity. You can observe the surface structures in high precision with secondary electron image in the high vacuum mode by applying conductive coating.

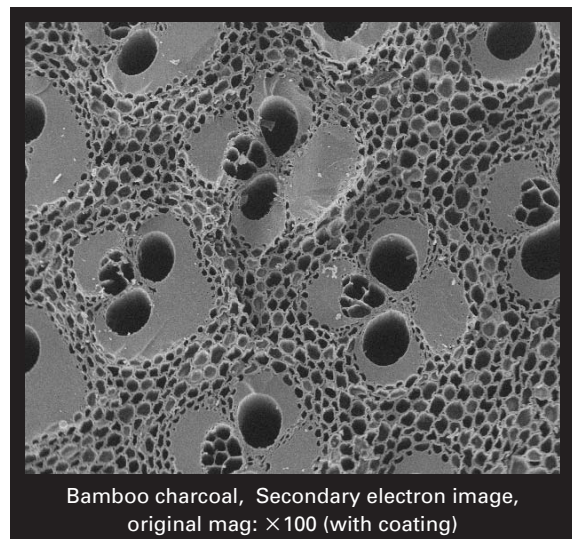
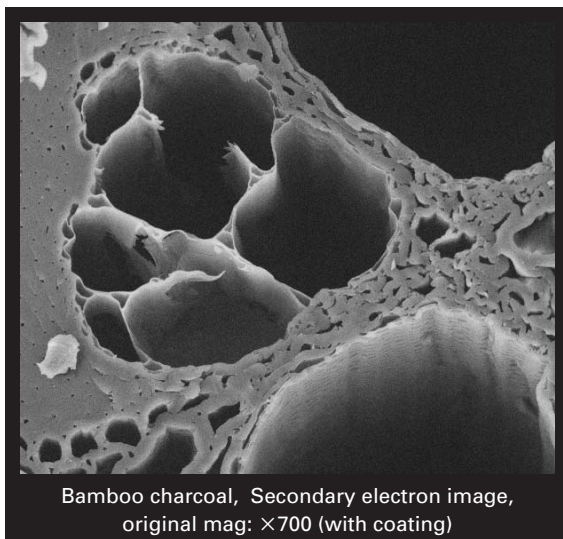
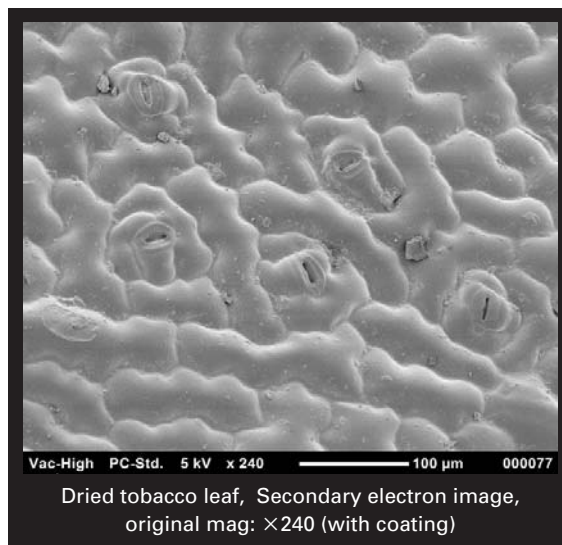
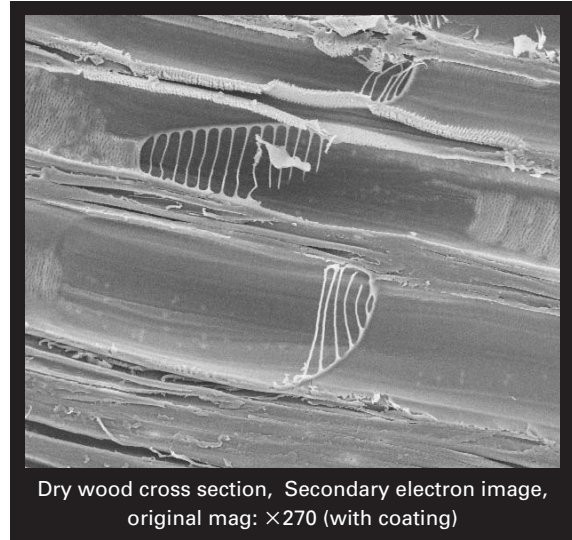
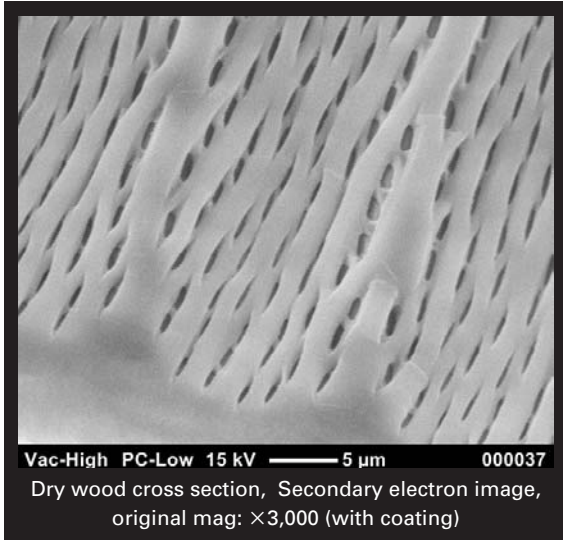



Fine structures of insects can be observed clearly in details at high magnification.  
The SE image is most suitable for observation of insects.

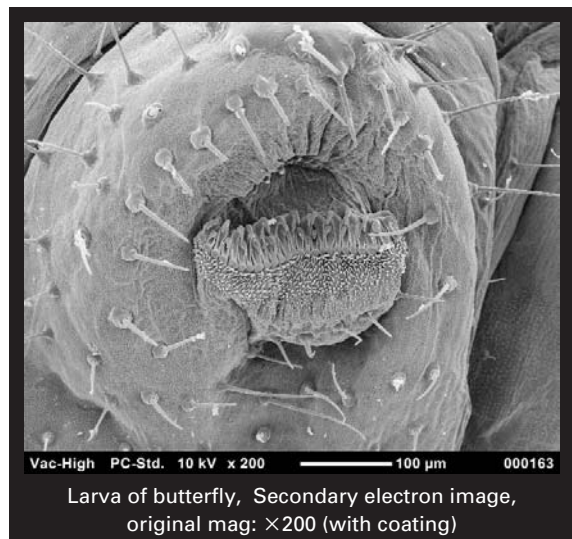
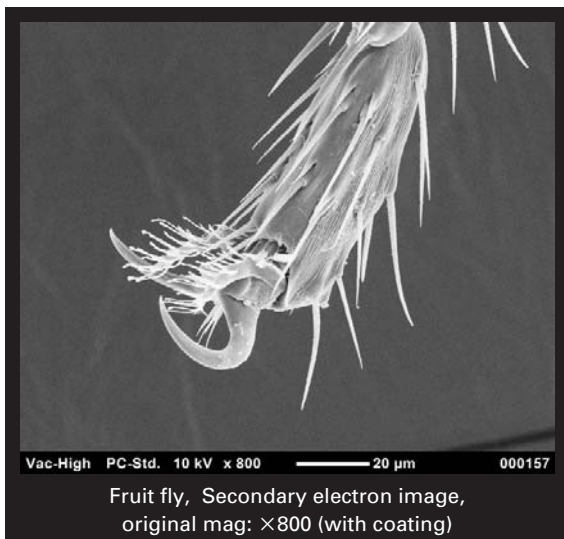
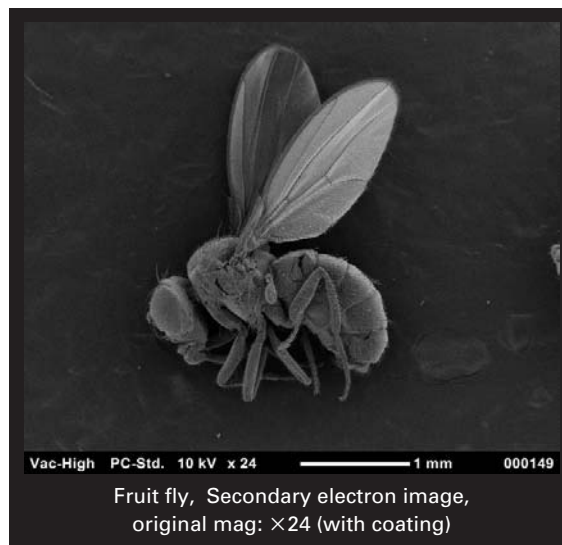
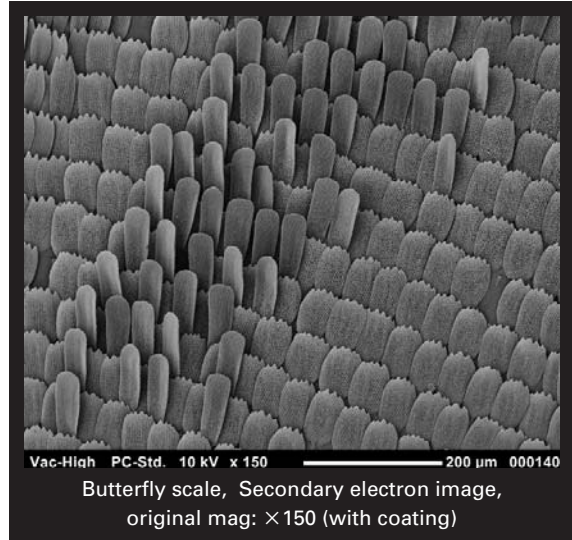
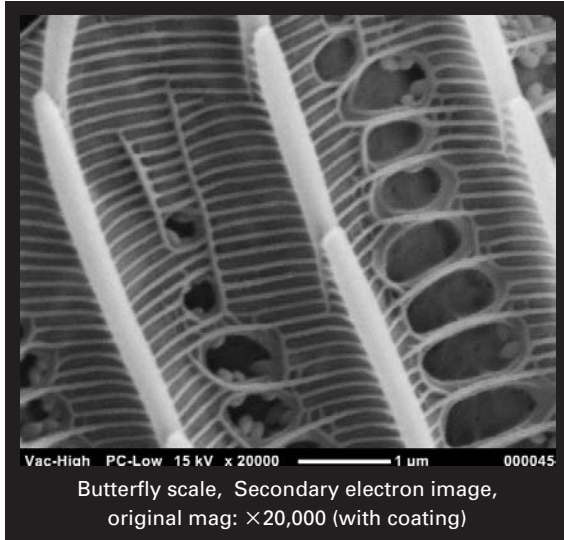





# Animal Organism SE image in high vacuum

Animal organism contains water and not suitable for observation in SEM. These specimens are prepared by chemical fixation, dehydration, and drying by freeze dry or by critical point dry. A dried specimen is applied with conductive coating and observed with SE image in high vacuum.

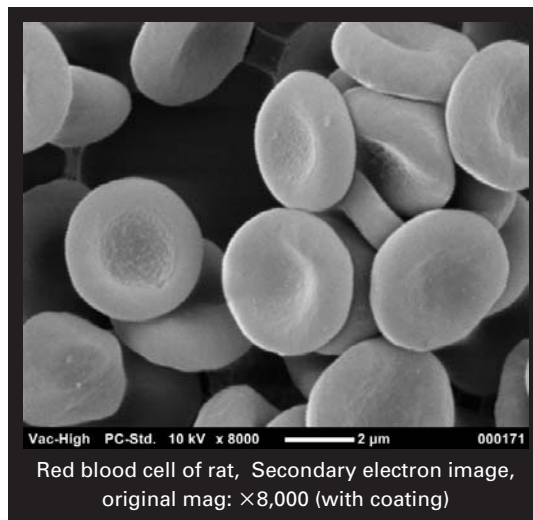
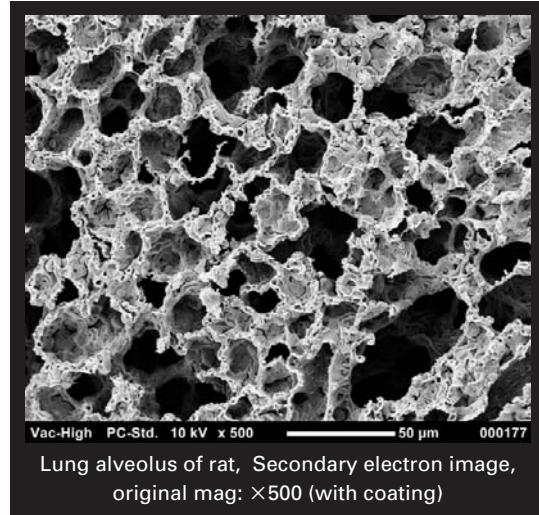
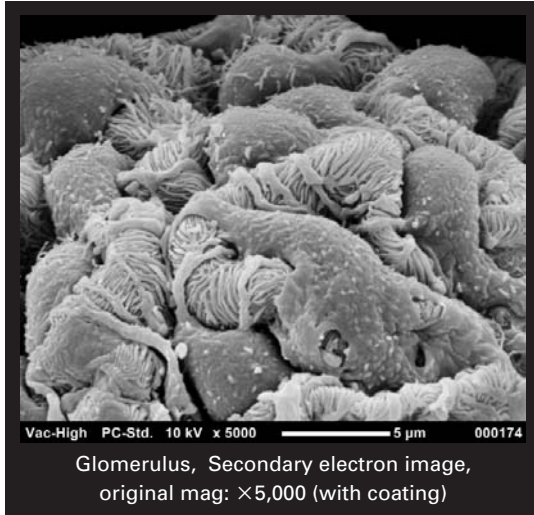

Egg shell is observed. You can observe the fine inner network. You can observe fine holes on the crystal structures in the shell.

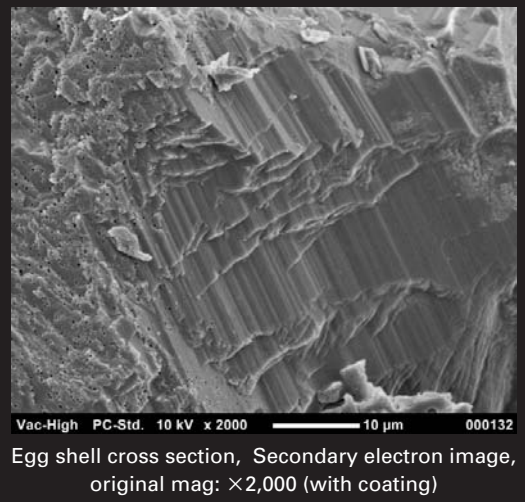
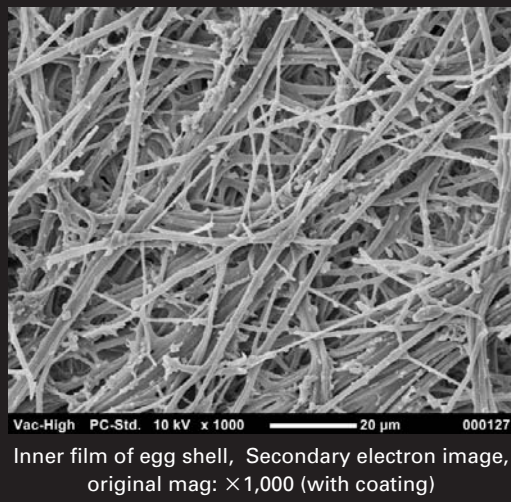



# Non conductive specimens Observed with SE image in high vacuum

You can observe a non-conductive specimen by using low voltage where the numbers of incident electrons and emitted electrons from a specimen are close or in the low vacuum mode by introducing small amount of air in the specimen chamber. In the low vacuum mode gas molecules are ionized by the incident electrons and neutralize the electrons accumulated on the specimen surface.

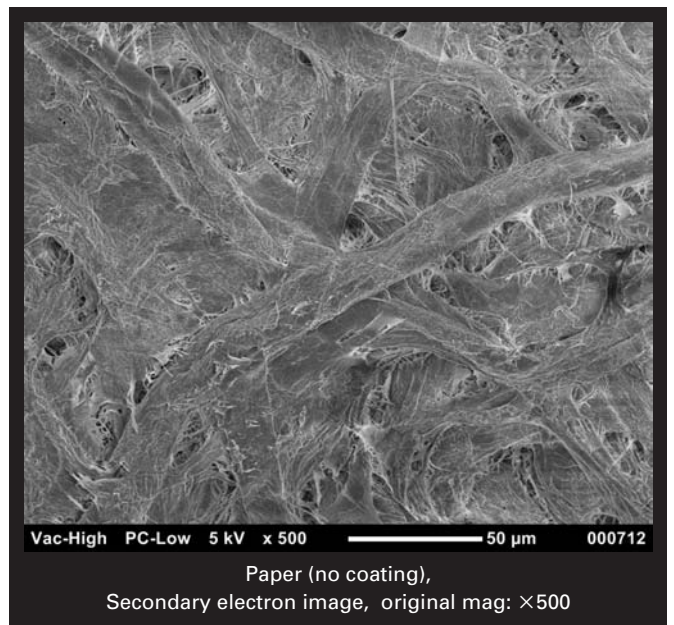
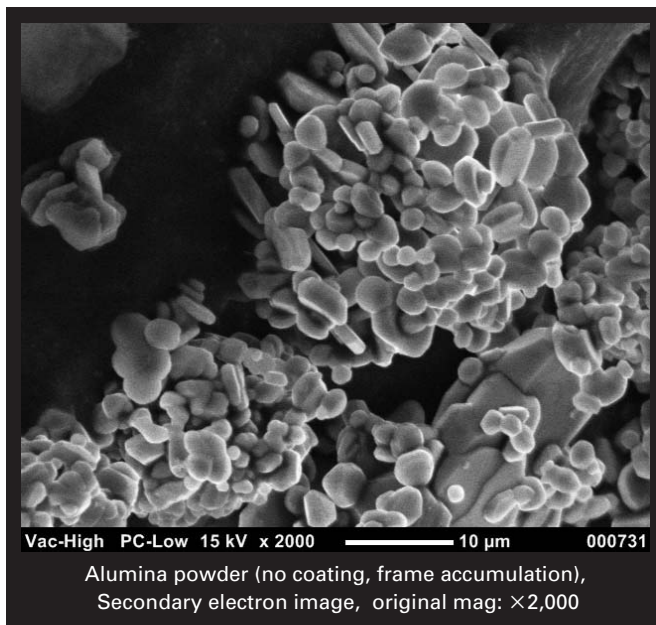
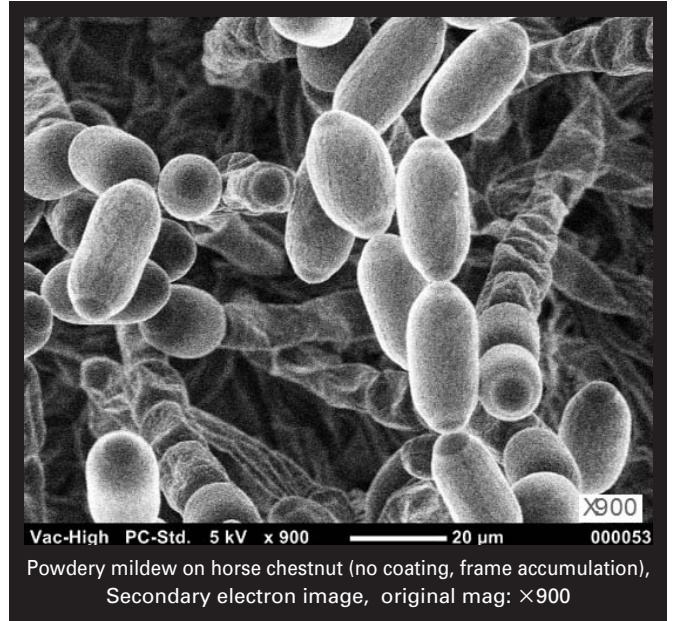
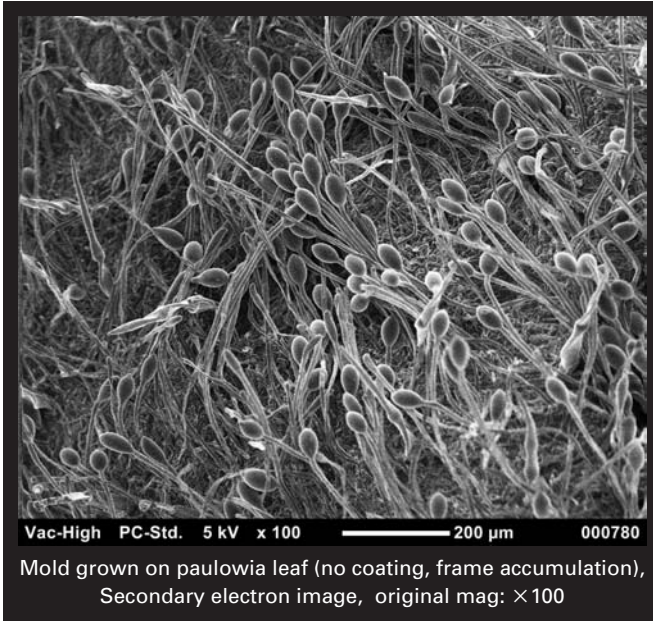





# Non conductive specimens Observed in low vacuum

When you introduce small amount of air into the specimen chamber to increase the pressure to 30Pa, about 10% of the incident electrons collide with gas molecules and generate ions. The ions neutralize the electrons accumulated on a non-conductive specimen surface. The electrons collided with gas molecules are scattered and reach over a wide area on the specimen. You observe backscattered electron (BSE) image in the low vacuum mode. BSE images are of slightly poorer resolution due to larger generation volume of backscattered electrons.

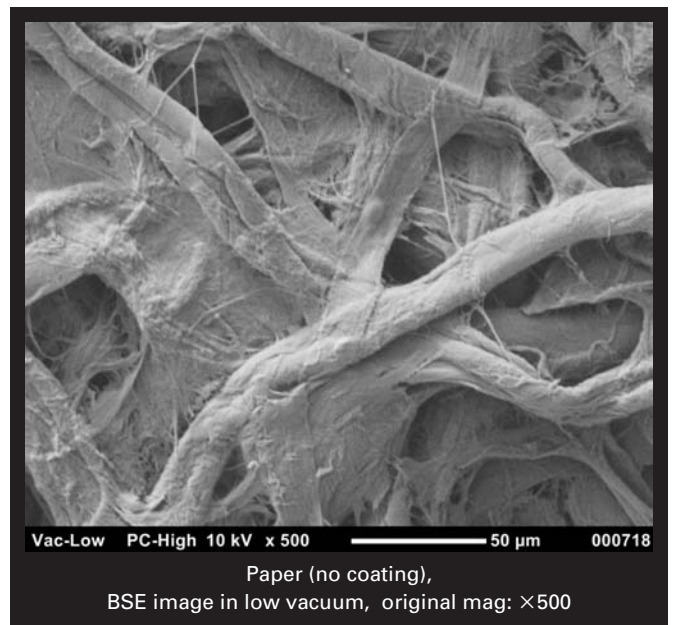
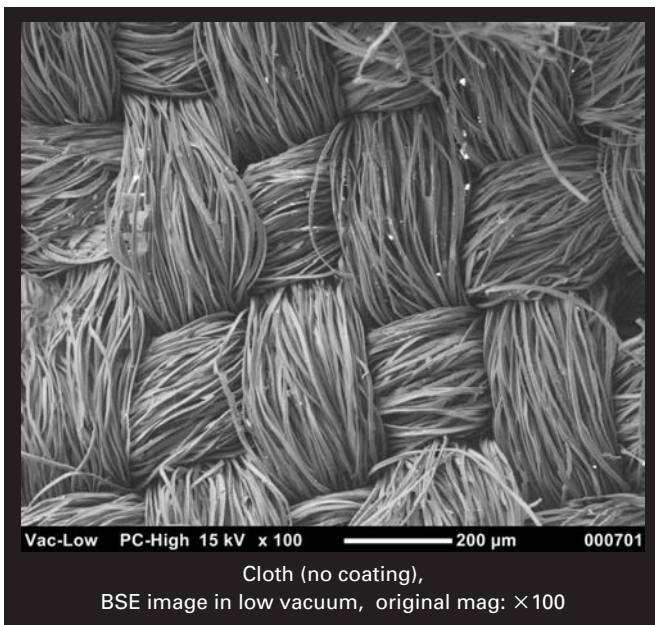
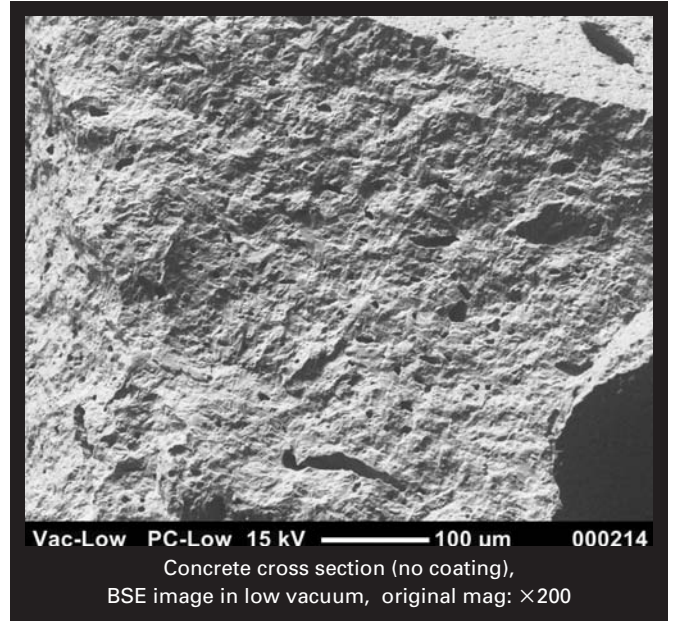



# Self Test and Simple Maintenance



# Neo cartridge

Neo Scope can be easily maintained by a user. When the SEM is not functioning properly, you can find the reason on the Self test window.

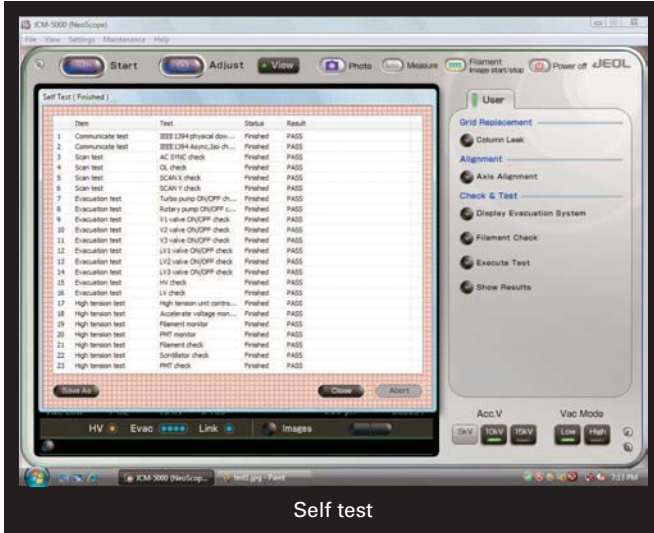

Self test

It is simple to change a filament.

NeoScope uses cartridge electron source, which is composed of electron gun and filament. Remove an old electron source and plug in a new one.

You can change filament by simple procedure in a short time.

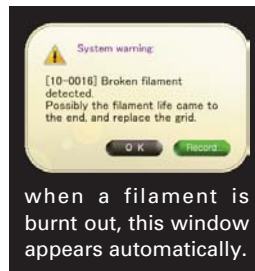

when a filament is burnt out, this window appears automatically.

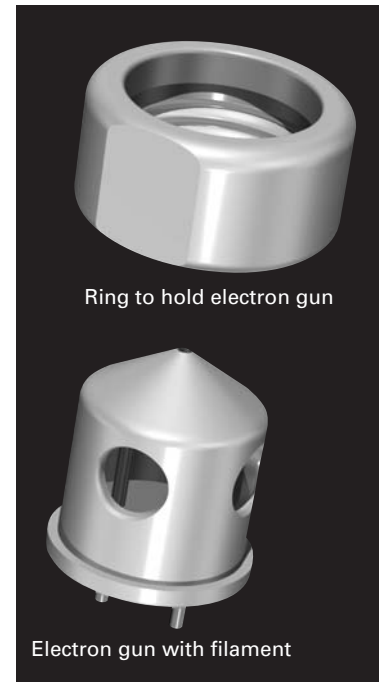

Ring to hold electron gun

Electron gun with filament



# NeoCoater (Option)

You can obtain a sharp and good quality image of a non-conductive specimen easily by applying conductive coating on a specimen. The conductive coating is only a few nm thick so that fine surface structures are not hidden. A sputter coater is used to apply conductive coating. You can form uniform coating film in a short time.



## NeoCoater

- Compact
- Easy to use
- Affordable Price

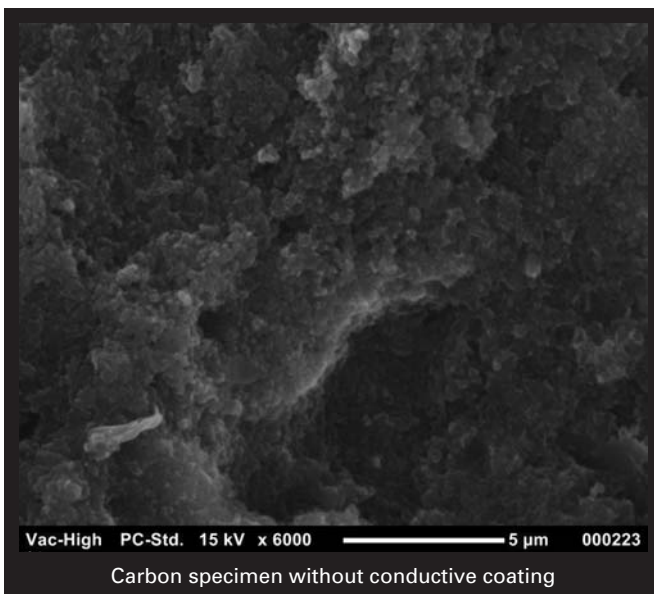

Carbon specimen without conductive coating



Carbon specimen with conductive coating of gold

Principal Specifications



Specifications	NeoScope
Magnification	×10~×40,000
Observation mode	High vacuum mode, Low vacuum mode
Electron source	Small cartridge electron source
Accelerating voltage	15kV, 10kV, 5kV
Specimen stage	Manual, X 35mm, Y 35mm
Specimen exchange	Specimen stage draw out
Maximum specimen size	70mm Diameter × 50mm Height
Detector	Secondary electron detector, Backscattered electron detector
Computer	Portable PC
OS	Windows Vista, Windows 7
Digital image	1,280 × 1,024 pixels, bmp, tif, jpg
Data display	Accelerating voltage, magnification, micron bar, micron value
Automatic operation	Electron source, focus, brightness, contrast, and astigmatism
Evacuation time	Approximately 3 minutes
Evacuation system	TMP, RP
Main console dimensions	W492 × D458 × H434mm

Installation requirement	
Electric power	Single phase AC100V (400VA) ~240V (1,100VA) 50Hz/60Hz
Power fluctuation	Less than ±10%
Grounding terminal	One, 100 Ω or less
Installation room	
Room temperature	15°C~30°C
Humidity	70% or less
Weight	
Main console	Approximately 69kg
PC	Approximately 11kg
RP	Approximately 16kg

NeoScope composition

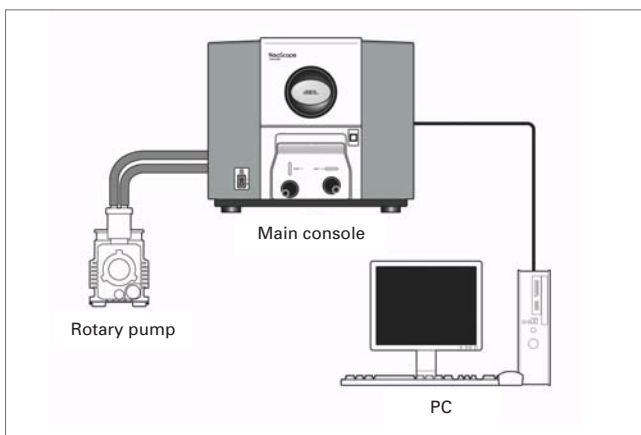

Wagon to add mobility (Option)



NeoCoater composition

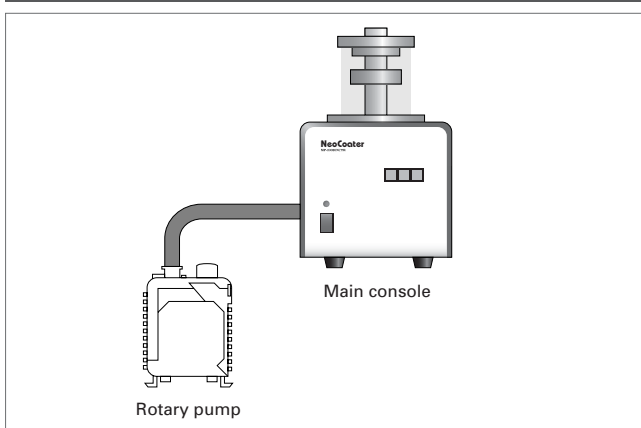

Specifications	NeoCoater
Composition	Main console + RP (20L/min)
Specimen table size	70mm diameter
Specimen table height	32mm to 73mm to the target
Power	Single phase 100V 50/60Hz 440W
Weight	Main console 9.3kg + RP9kg
Operation vacuum	~4Pa
Sputter time	1 min (standard), 2 min, 3 min selectable
Target	Au
Target size	ø49 × 0.05mm
Main console dimension	W200 × D230 × H325mm

\*Specifications subject to change without notice.



# NeoScope

## JCM-5000

Table Top SEM



Specifications and equipment are subject to change without any notice or obligation on the part of the manufacturer. ©2009 NIKON CORPORATION

The products detailed in the brochure are controlled by the Japanese Foreign Exchange and Foreign Trade Law and the International Export Control Regime. If there is a possibility that they may be utilized for the development of weapons of mass destruction, etc., they shall not be exported without authorization from the government.



**WARNING**

TO ENSURE CORRECT USAGE, READ THE CORRESPONDING MANUALS CAREFULLY BEFORE USING THE EQUIPMENT.



### NIKON CORPORATION

6-3, Nishiohi 1-chome, Shinagawa-ku,  
Tokyo 140-8601, Japan  
phone: +81-3-3773-9026 fax: +81-3-3773-9062  
<http://nikon.com/products/instruments/>

### NIKON INSTRUMENTS INC.

1300 Walt Whitman Road, Melville, N.Y. 11747-3064, U.S.A.  
phone: +1-631-547-8500; +1-800-52-NIKON (within the U.S.A. only)  
fax: +1-631-547-0306

<http://www.nikoninstruments.com/>

### NIKON INSTRUMENTS EUROPE B.V.

Laan van Kronenburg 2, 1183 AS, Amstelveen, The Netherlands  
phone: +31-20-44-96-222 fax: +31-20-44-96-298

<http://www.nikoninstruments.eu/>

### NIKON INSTRUMENTS (SHANGHAI) CO., LTD.

CHINA phone: +86-21-5836-0050 fax: +86-21-5836-0030  
(Beijing branch) phone: +86-10-5869-2255 fax: +86-10-5869-2277  
(Guangzhou branch) phone: +86-20-3882-0550 fax: +86-20-3882-0580

### NIKON SINGAPORE PTE LTD.

SINGAPORE phone: +65-6559-3618 fax: +65-6559-3668

### NIKON MALAYSIA SDN. BHD.

MALAYSIA phone: +60-3-7809-3609 fax: +60-3-7809-3633

### NIKON INSTRUMENTS KOREA CO., LTD.

KOREA phone: +82-2-7196-9400 fax: +82-2-556-4416



ISO 9001 Certified  
NIKON CORPORATION  
Instruments Company



ISO 14001 Certified  
NIKON CORPORATION  
Yokohama Plant

### NIKON UK LTD.

UNITED KINGDOM phone: +44-20-8247-1717 fax: +44-20-8541-4584

### NIKON GMBH AUSTRIA

AUSTRIA phone: +43-1-972-6111-00 fax: +43-1-972-6111-40

### NIKON BELUX

BELGIUM phone: +32-2-705-56-65 fax: +32-2-726-66-45



# (주)엔아이텍

## NEW INSTRUMENTS TECHNOLOGY

[www.nitech.co.kr](http://www.nitech.co.kr) Tel. 02-6925-1048